

FOR PUSHBUTTON AND TOGGLE SWITCHES

## Shrouds

Shrouds are added to pushbutton switches to guard against inadvertent actuation. The actuating device must be inserted into the shroud in order to actuate the switch. We have an assortment from which to choose shown here. We are also able to design and fabricate a shape to meet your specifications and application needs.

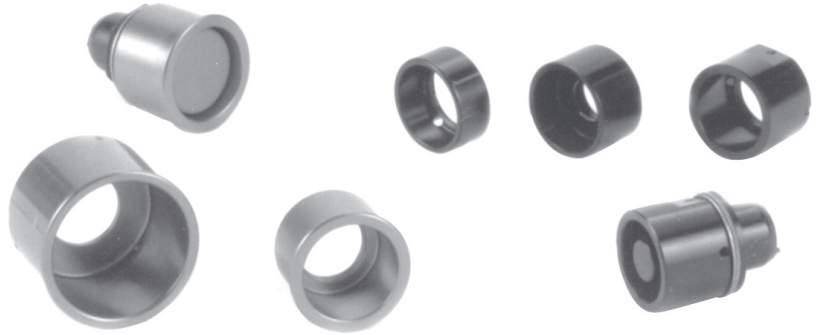

### Material:

Aluminum alloy, machined to specification.

### Finish:

Black anodized. For other color options, contact factory.

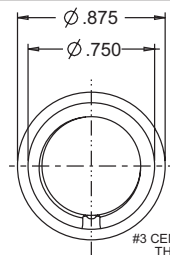

**OTTO P/N C300793**

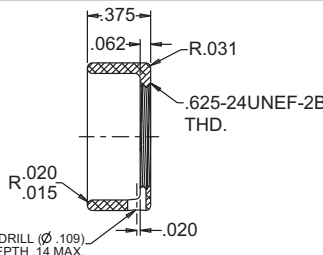

**OTTO P/N C300428**

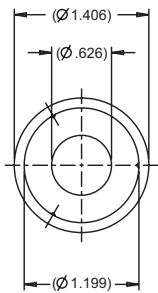
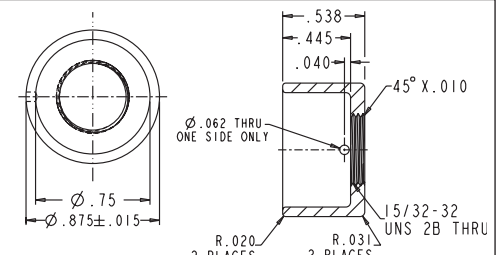

**OTTO P/N C300302**

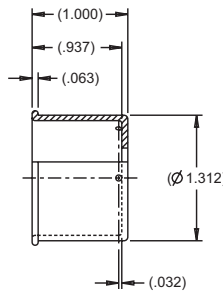

**OTTO P/N C300871**

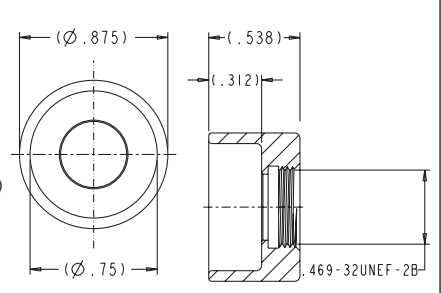
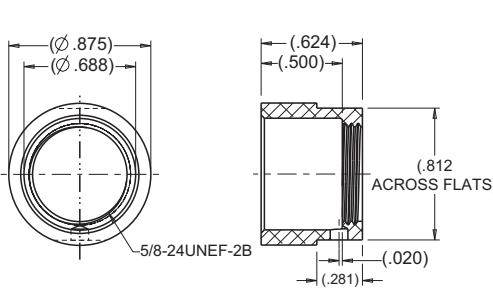

**OTTO P/N C300426**

## Panel Seals

Stainless steel cup washer with silicone rubber seal assures proper watertight panel seal. Mounts behind panel. Approved to MIL-DTL-5423/16. Designed for sealing 15/32" bushing with keyway. Available in packages of 25.

OTTO P/N: C710196  
MIL-DTL-5423/16

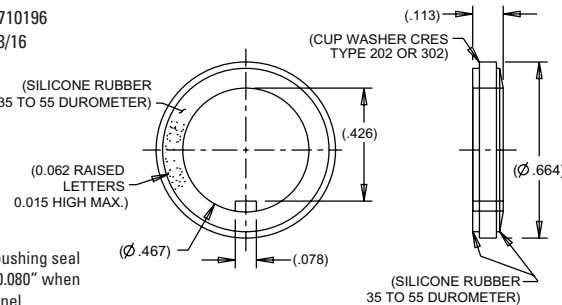

Thickness of bushing seal is reduced to 0.080" when mounted to panel.

### Gaskets

### O-Rings (Buna)

OTTO P/N	I.D.	OTTO P/N	I.D.
C700117-25	0.250"	C801568-010	0.250"
C700110-25	0.469"	C802568-015	0.500"
C700109-25	0.625"	C802568-016	0.625"

## Mounting Hardware

### MILITARY P/N

### OTTO P/N

### BUSHING SIZE (inches)

### KEYWAY WASHERS

MS25081-C0	C710081-C0	0.250"
MS25081-C4	C710081-C4	0.469"
MS25081-C6	C710081-C6	0.625"

### INTERNAL TOOTH LOCKWASHERS

MS35333-135	C710333-135	0.250"
MS35333-136	C710333-136	0.469"

### HEX NUTS—STANDARD

MS25082-C14	C710082-C14	0.250-40
MS25082-C21	C710082-C21	0.469-32
MS25082-B11	C710082-B11	0.625-24

### HEX NUTS—WIRE LOCKING

MS21340-04	C710340-04	0.469-32
MS21340-05	C710340-05	0.625-24